

NatGlycan --- High Quality Glycans at Affordable Prices

High mannose type N-glycan

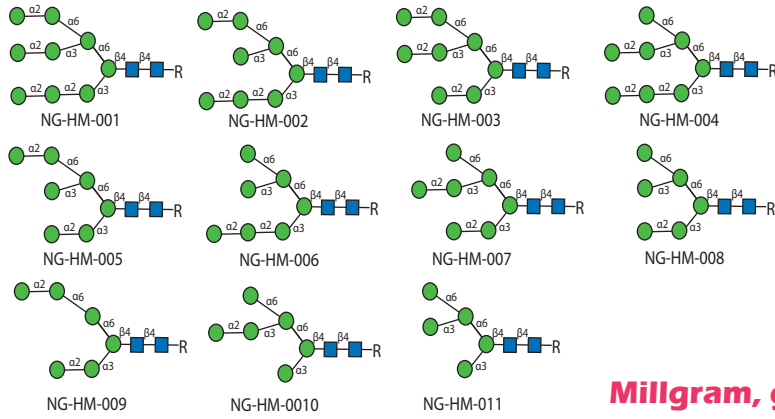

Bisecting N-glycan

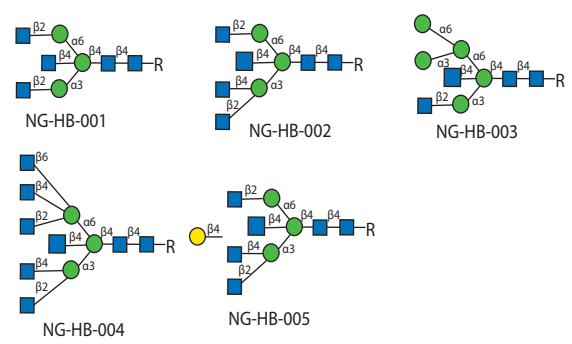

Milligram, gram or multi-gram quantities available!

Complex type N-glycan

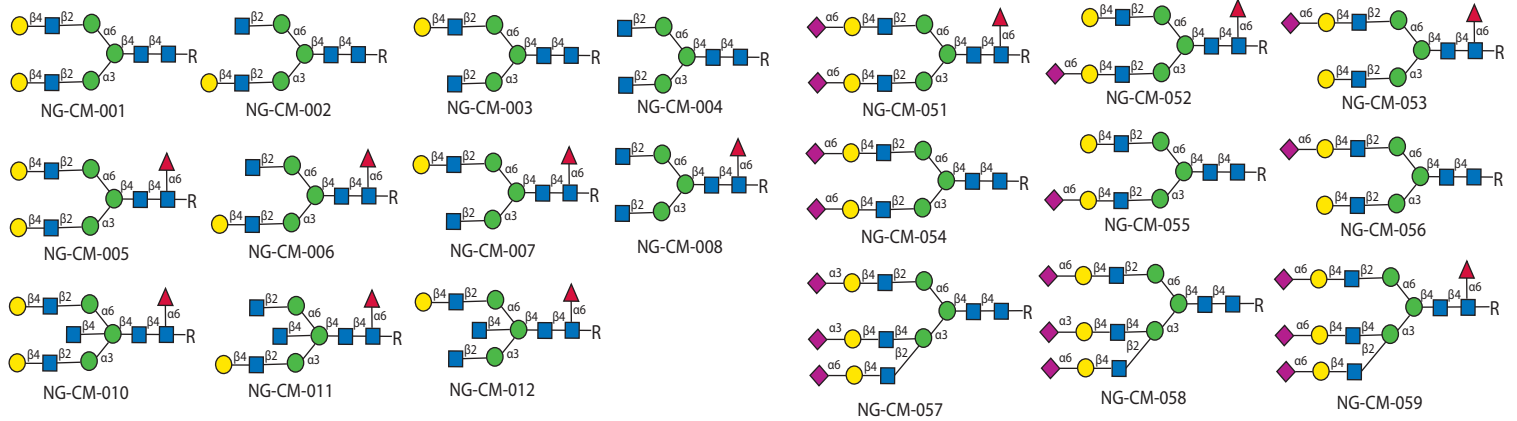

Endo-glycosynthase substrates

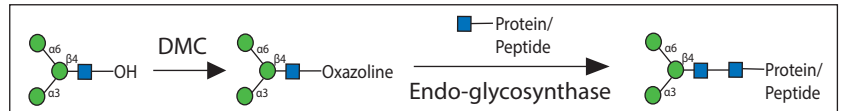
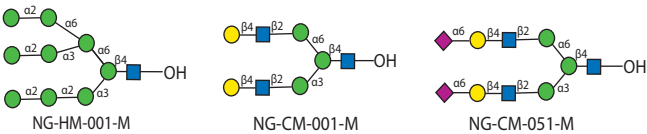

Mucin type O-glycan

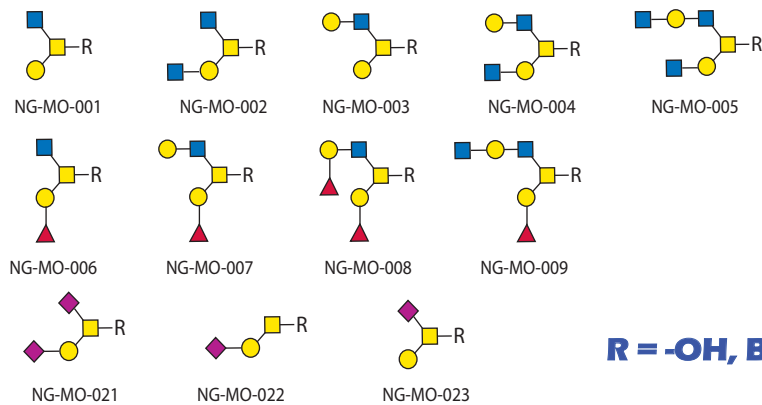

Glycosphingolipid glycan

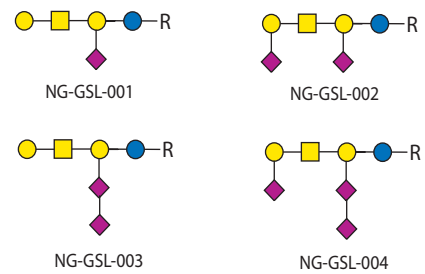

R = -OH, Biotin, 2-AA, 2-AB, AEAB, or other tags

Natural Glycan libraries

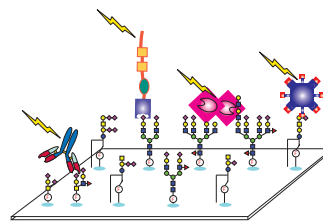
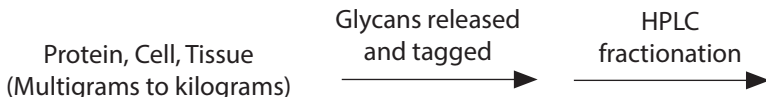

Contact us at: info@natglycan.com